



Rapide Cylinders



Mikrofill range of stainless steel hot water cylinders

The Mikrofill Rapide range of WRAS approved cylinders from 150 to 500 litres meet the highest standards of performance and durability. Advanced production in accordance with strict quality standards (DIN 4753, CE), extensive test procedures prior to delivery, 100% 316 grade stainless steel construction, no anodes, high heat transfer, maintenance free, low weight, 25 year guarantee unsurpassed technical and service support.

TECHNICAL DATA	RAPIDE 150	RAPIDE 200	RAPIDE 300	RAPIDE 500
DHW Capacity (L)	150	200	300	500
Primary Coil Capacity (L)	4.8	5.8	8.8	12
Primary Coil Area m ²	0.79	0.95	1.42	1.88
DHW Flow Rate (max) L/min	13.6	16.7	21.5	26.3
Recovery Time (10o – 60o) min	16	20	19	25
Max Power Input (Kw)	30	40	55	75
Continuous Output (L/hr)*	560	718	947	1200
1st hr Max Output (L)*	710	918	1247	1700
Connections	See Diagrams			
Primary Coil Resistance	See Graphs			
Cold Water Conn	3/4"	3/4"	1"	1"
Primary Coil Pressure (Bar)	3.5	3.5	3.5	3.5
Pressure Relief (Bar)	6.00	6.00	6.00	6.00
Temp/Pressure Relief °C/bar	90/6	90/6	90/6	90/6
Expansion Vessel (L)	18	18	35	35
Weight (kg)	43.5	50.0	56.0	67.0
WRc Approval Number	0302094			

* Based on Δt of 50° i.e. 10°C cold water inlet, 60°C at DHW outlet and max power input

MATERIAL SPECIFICATIONS	
Tank	W.No. 1.4571 (AISI 316Ti) in accordance with DIN 17441
Connections	W.No. 1.4401 (AISI316) in accordance with DIN 17440/17441
Coil	W. No. 1.4401 (AISI 316) in accordance with DIN 17441
Operational pressure heating coil	Up to 40 BAR
Surface treatment	Pickled and passivated
Technical structure	In accordance with DIN 4753

RAPIDE 150

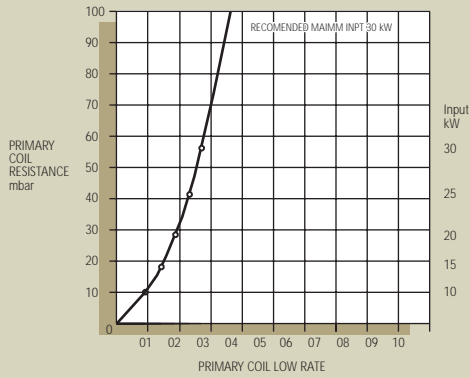

RAPIDE 200

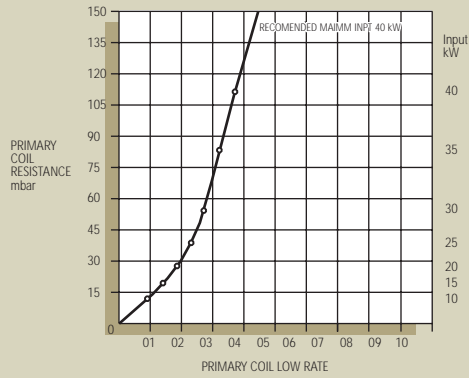

RAPIDE 300

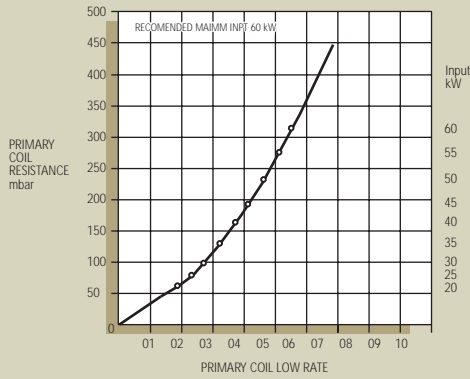

RAPIDE 500

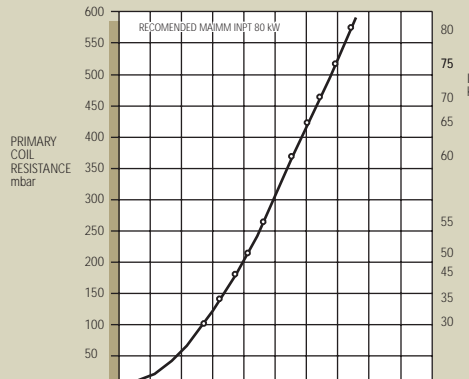

RAPIDE WIRING DIAGRAM KW 1PH

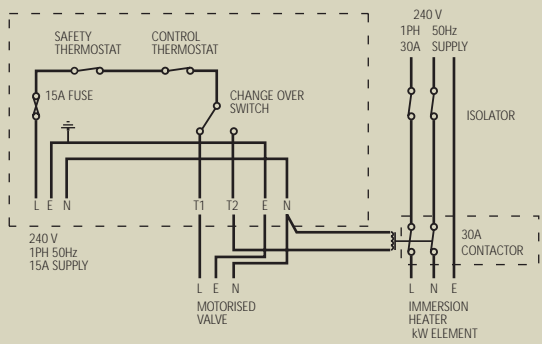

RAPIDE WIRING DIAGRAM 3kW 1PH

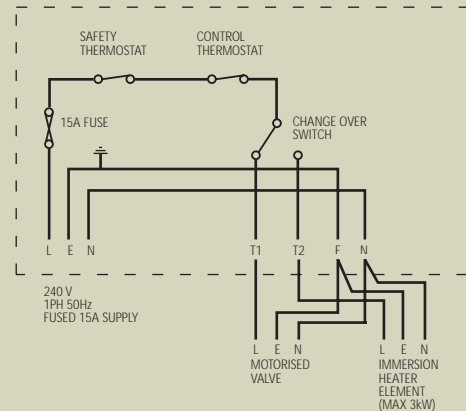

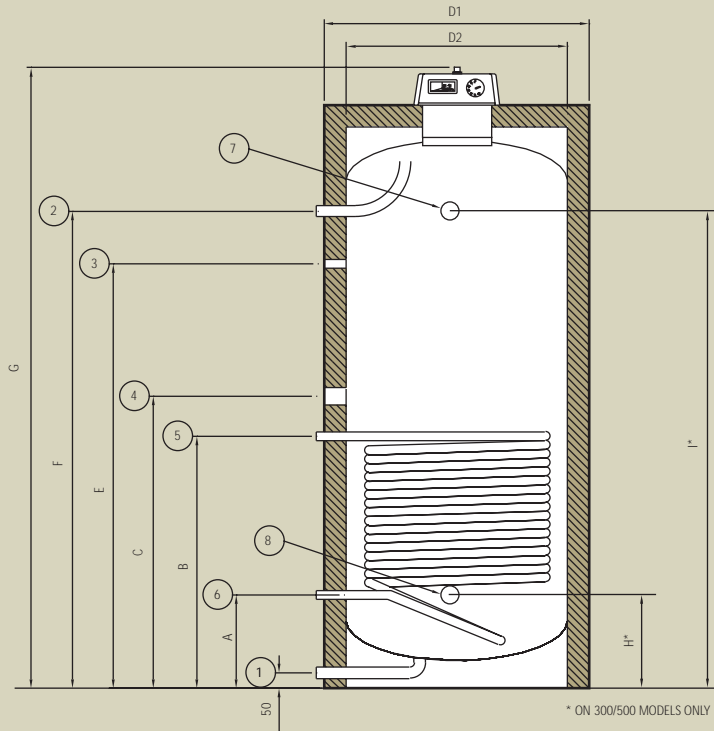

DIMENSIONS (mm)										
MODEL	A	B	C	D1	D2	E	F	G	H	I
150	240	640	740	506	400	1065	1170	1495	-	-
200	250	660	760	603	500	880	1000	1325	-	-
300	270	790	890	600	500	1290	1510	1855	270	510
500	310	830	930	810	635	1330	1515	1955	310	515

	SIZE		DESCRIPTION
	150/200	300/500	
1	3/4"	1"	Cold feet/Drain
2	3/4"	1"	DHW Outlet
3	3/4"	3/4"	DHW Return
4	1 1/2"	1 1/2"	Immersion Element
5	3/4"	3/4"	Primary Flow
6	3/4"	3/4"	Primary Return
7	-	1/2"	Auxiliary Tapping
8	-	1/2"	Auxiliary Tapping